

NO.	NOTES
1	REFERENCE DRAWING #A0994 FOR FILTER TUBE DIMENSIONS
2	DIFFUSE REFLECTOR MATERIAL: ULTRA HIGH PURITY BaSO ₄ AND TEFLON FLOURINATED ETHYLENE PROPYLENE (FEP)

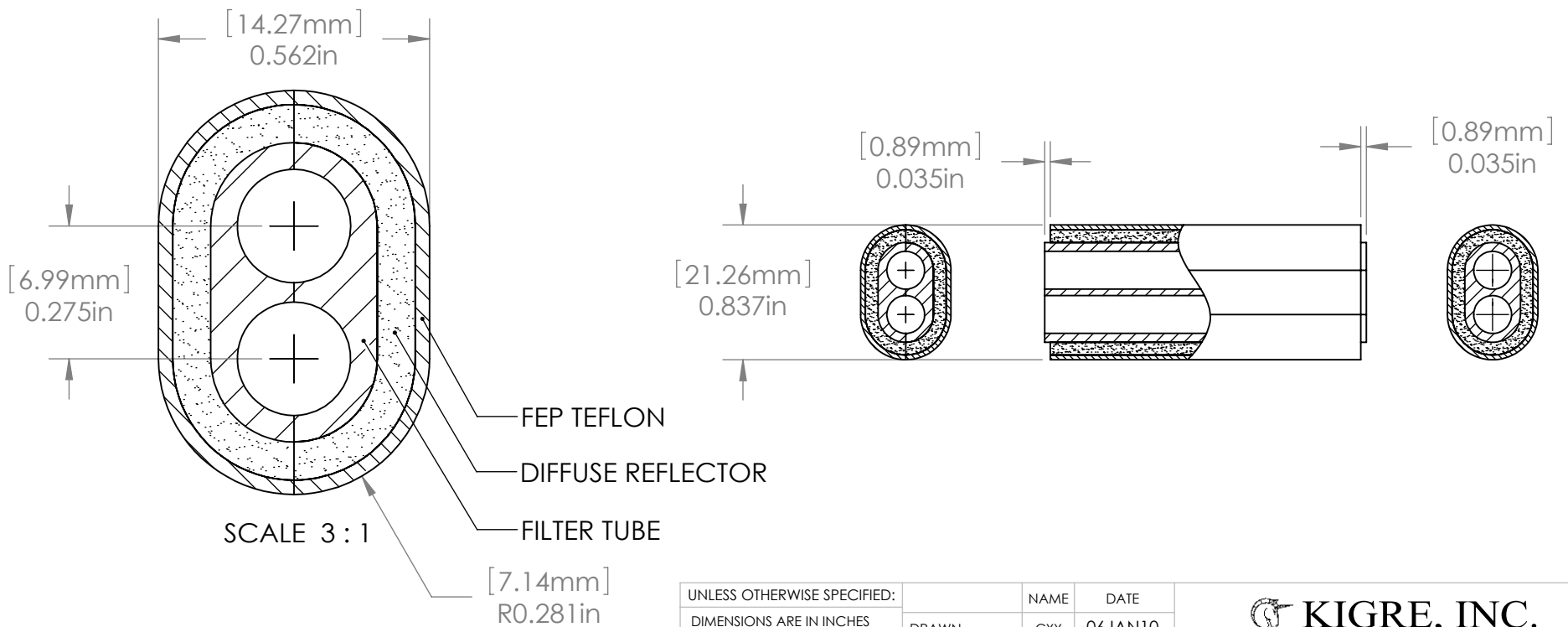

UNLESS OTHERWISE SPECIFIED:

DIMENSIONS ARE IN INCHES
 (EXCEPT WHERE NOTED)
 TOLERANCES:
 ONE PLACE DECIMAL ±0.020
 TWO PLACE DECIMAL ±0.010
 THREE PLACE DECIMAL ±0.005

INTERPRET GEOMETRIC TOLERANCING PER:

MATERIAL SEE NOTES 2

FINISH

DO NOT SCALE DRAWING

NAME DATE

DRAWN CXY 06JAN10

CHECKED CRH 06JAN10

ENG APPR.

MFG APPR.

Q.A.

COMMENTS:

KIGRE, INC.

TITLE:

PACKED FILTER TUBE DIMENSIONS

275/2

SIZE	DWG. NO.	REV
A	A3260	0

SCALE: 1:1	WEIGHT:	SHEET 1 OF 1
------------	---------	--------------

REV	DATE	DESCRIPTION	BY	APPR

PROPRIETARY AND CONFIDENTIAL THE INFORMATION CONTAINED IN THIS DRAWING IS THE SOLE PROPERTY OF KIGRE, INC.. ANY REPRODUCTION IN PART OR AS A WHOLE WITHOUT THE WRITTEN PERMISSION OF KIGRE, INC. IS PROHIBITED.	NEXT ASSY	USED ON
	APPLICATION	

5

4

3

2

1